

Lil' Ripper

Designed by: Shaun Frank

www.3DMONDESIGNS.com

Plans are for personal use only.

Parts are for 6mm foam and 1/16" plywood

Wingspan: 31"

Length: 31.5"

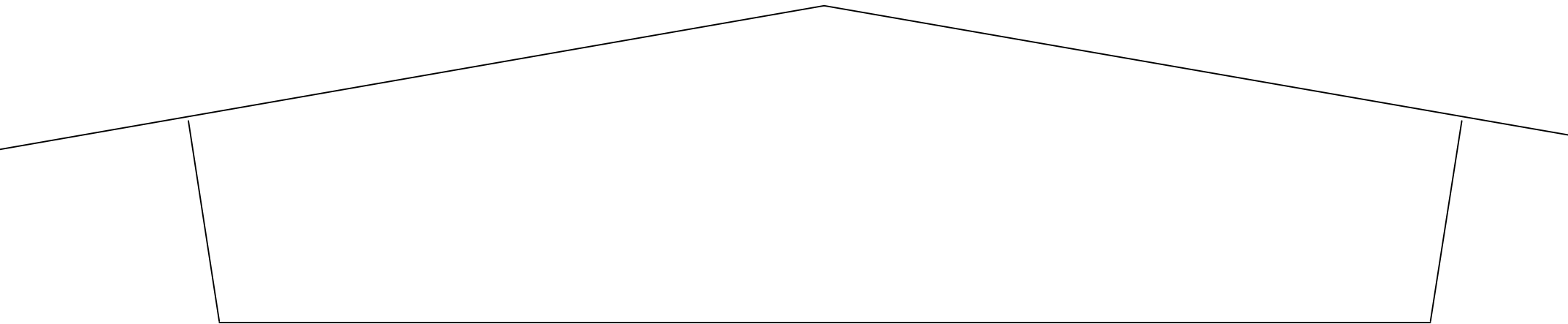

.120" x 5" Carbon tube

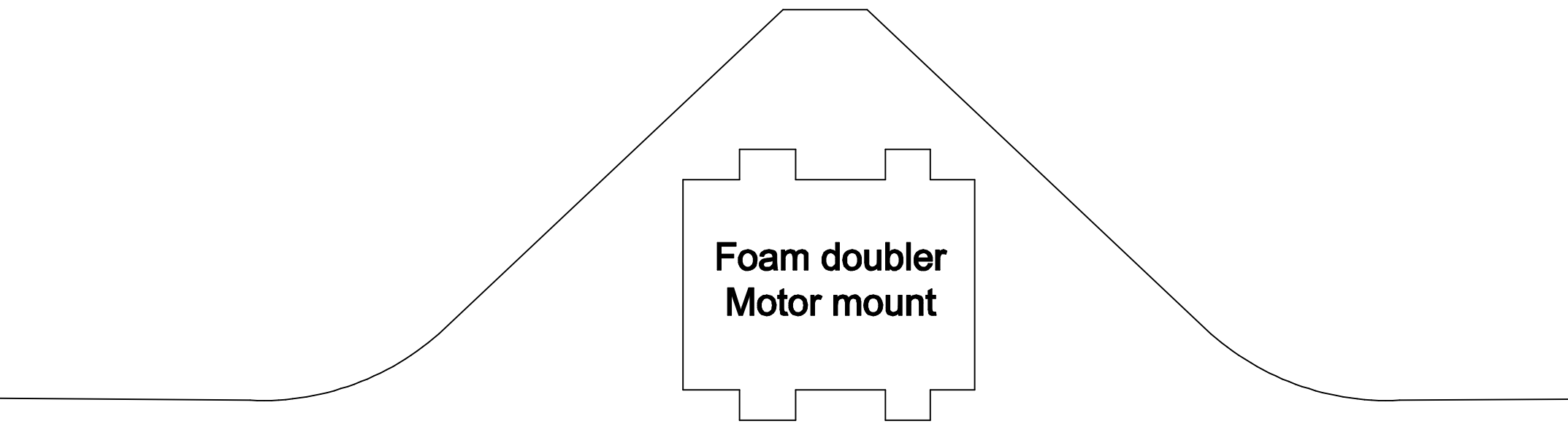
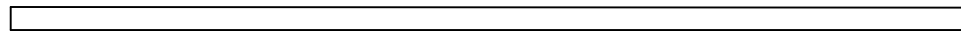

**Foam doubler
Motor mount**

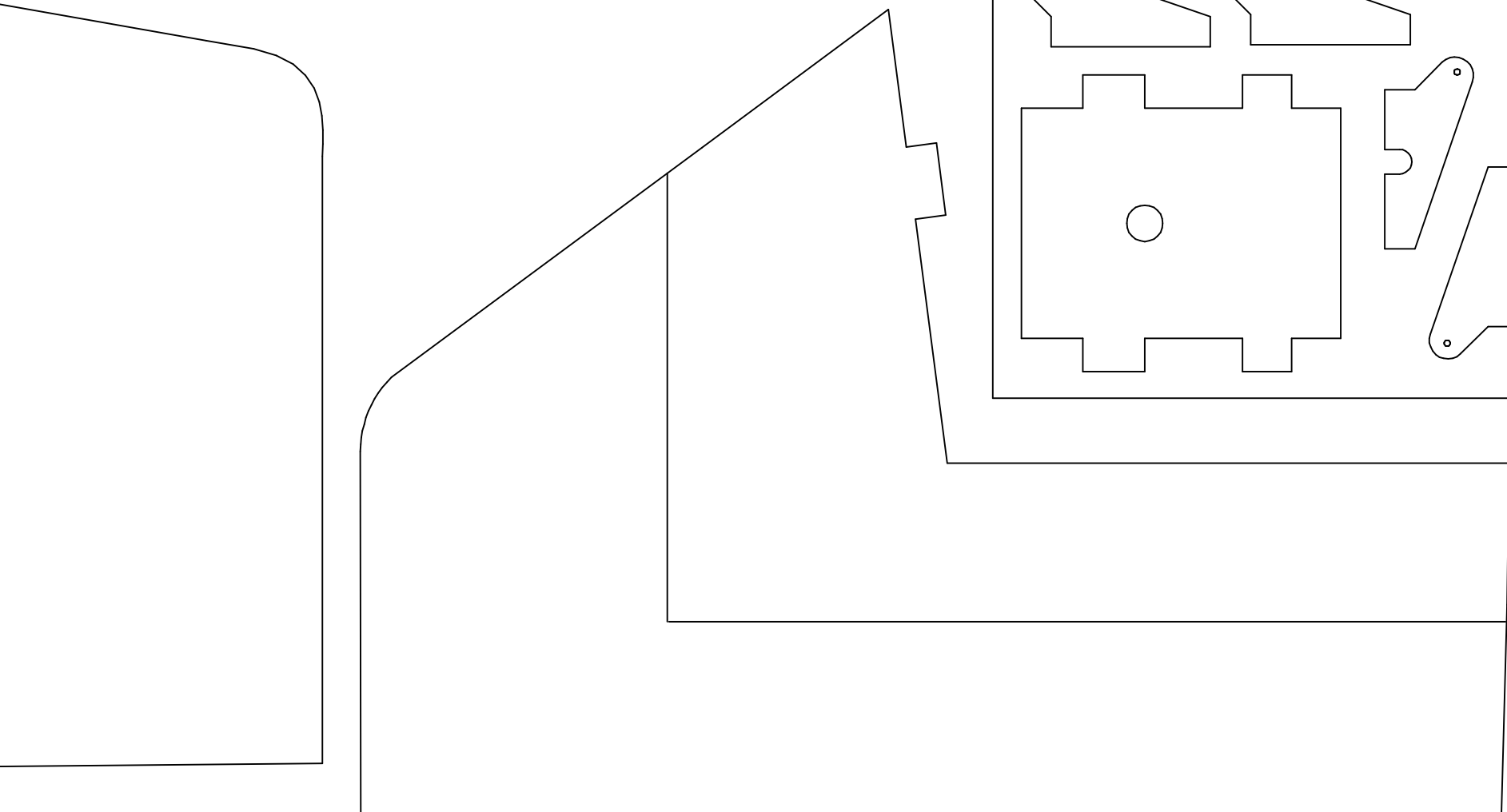

1/16" Plywood pieces

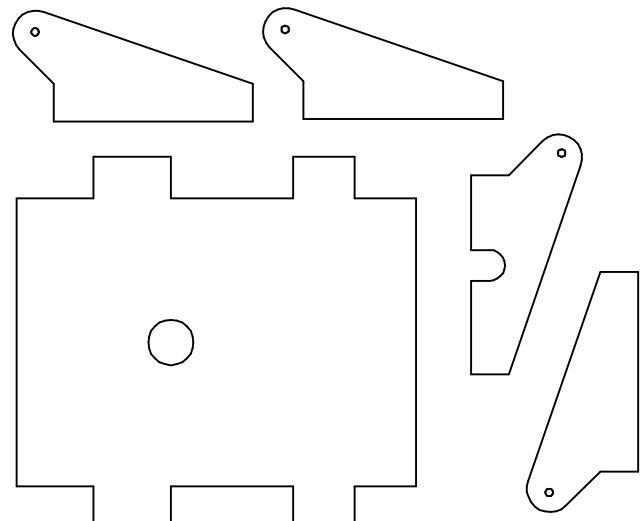

Flying Weight: 9-11 oz's

Motor: 24g 1300-1500kv "Blue Wonder"

Speed Control: 10-15 amp

Battery: 3s 500-800 mah

Servos: Hitec HS-55 or similar

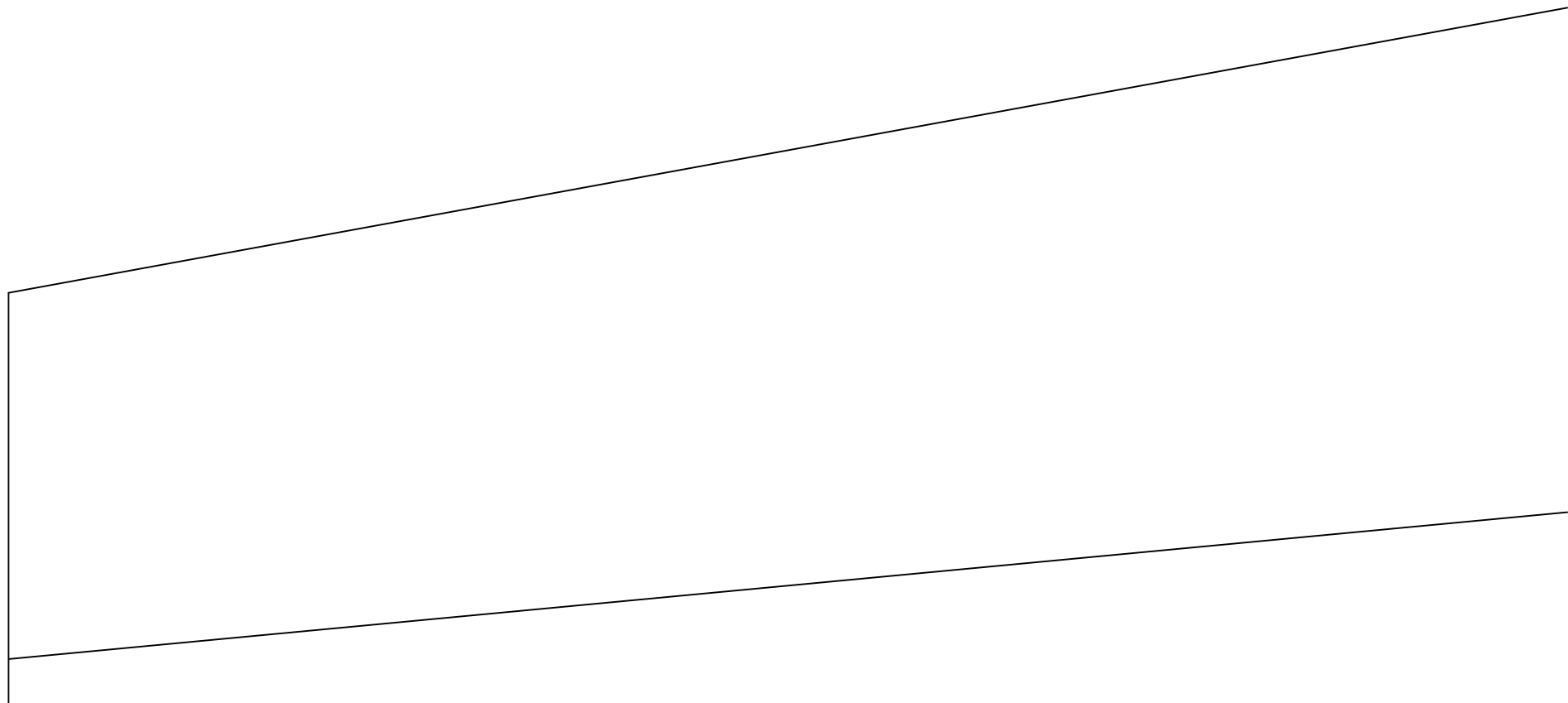

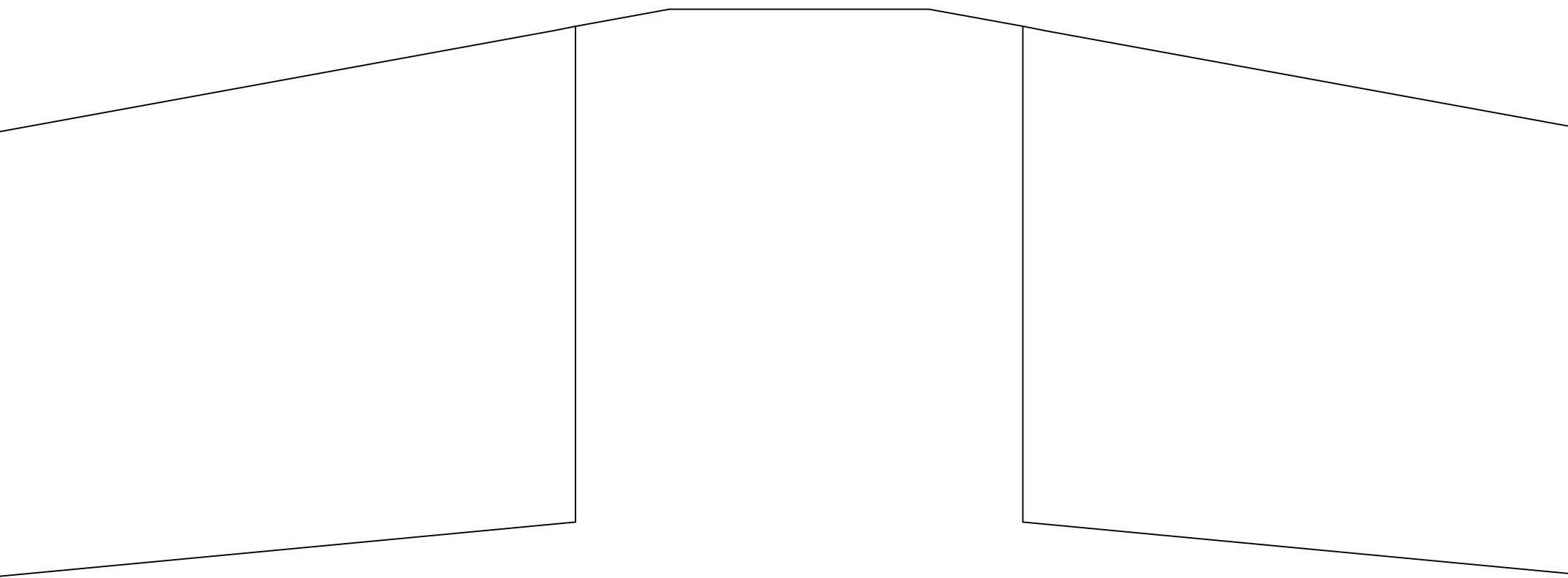



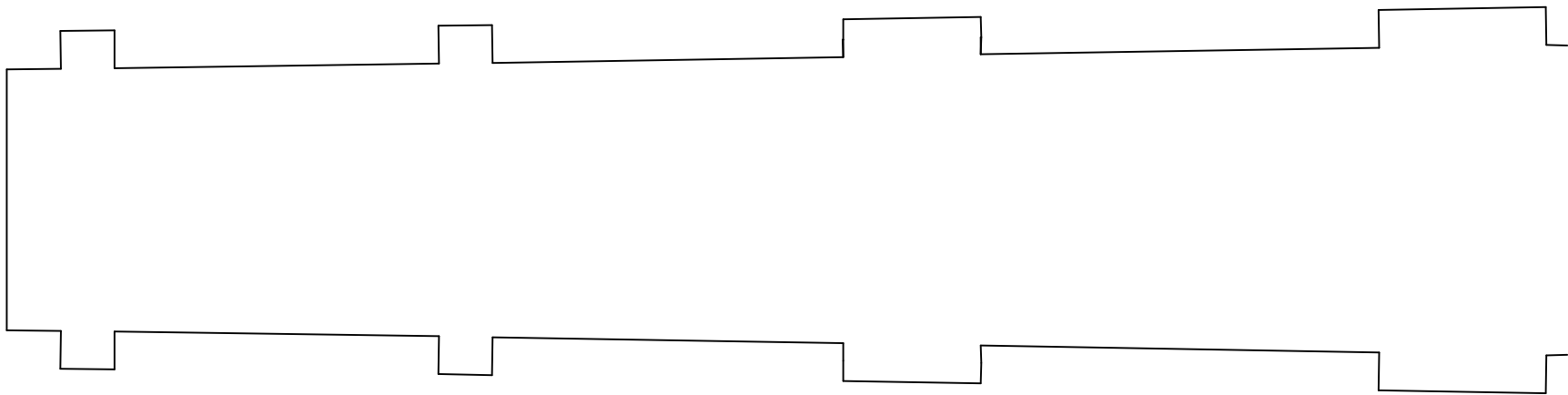
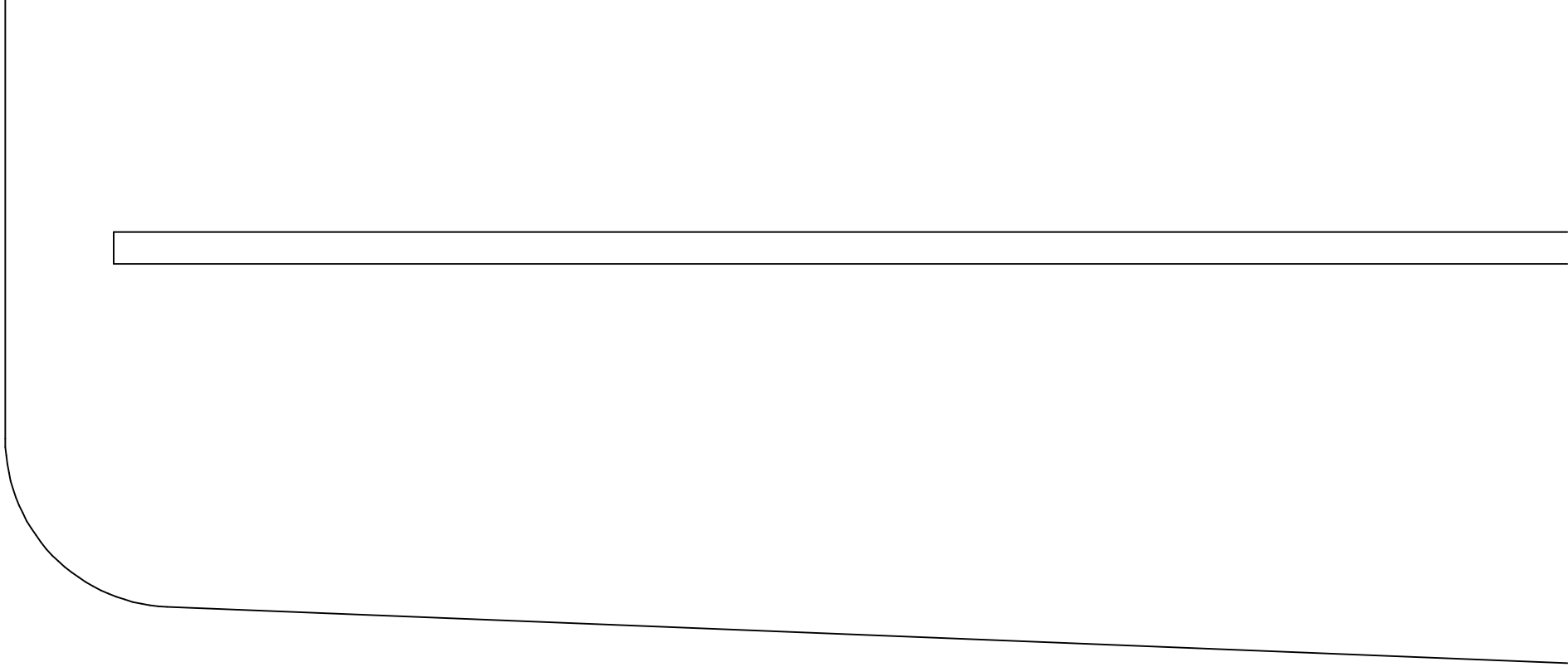



.210" x 29.5" Carbon tube for wing spar

Cooling vent

A technical diagram of a wing spar. It consists of two main lines representing the upper and lower surfaces of the spar. The upper line starts at a certain height on the left, dips slightly, then rises to a higher, constant height. The lower line starts at a lower height on the left, rises to a lower, constant height. Two rectangular blocks, representing cooling vents, are attached to the upper surface of the spar. The first vent is located on the lower section of the upper surface, and the second vent is located on the higher section. A label 'Cooling vent' is enclosed in a rounded rectangular box and points to the first vent.

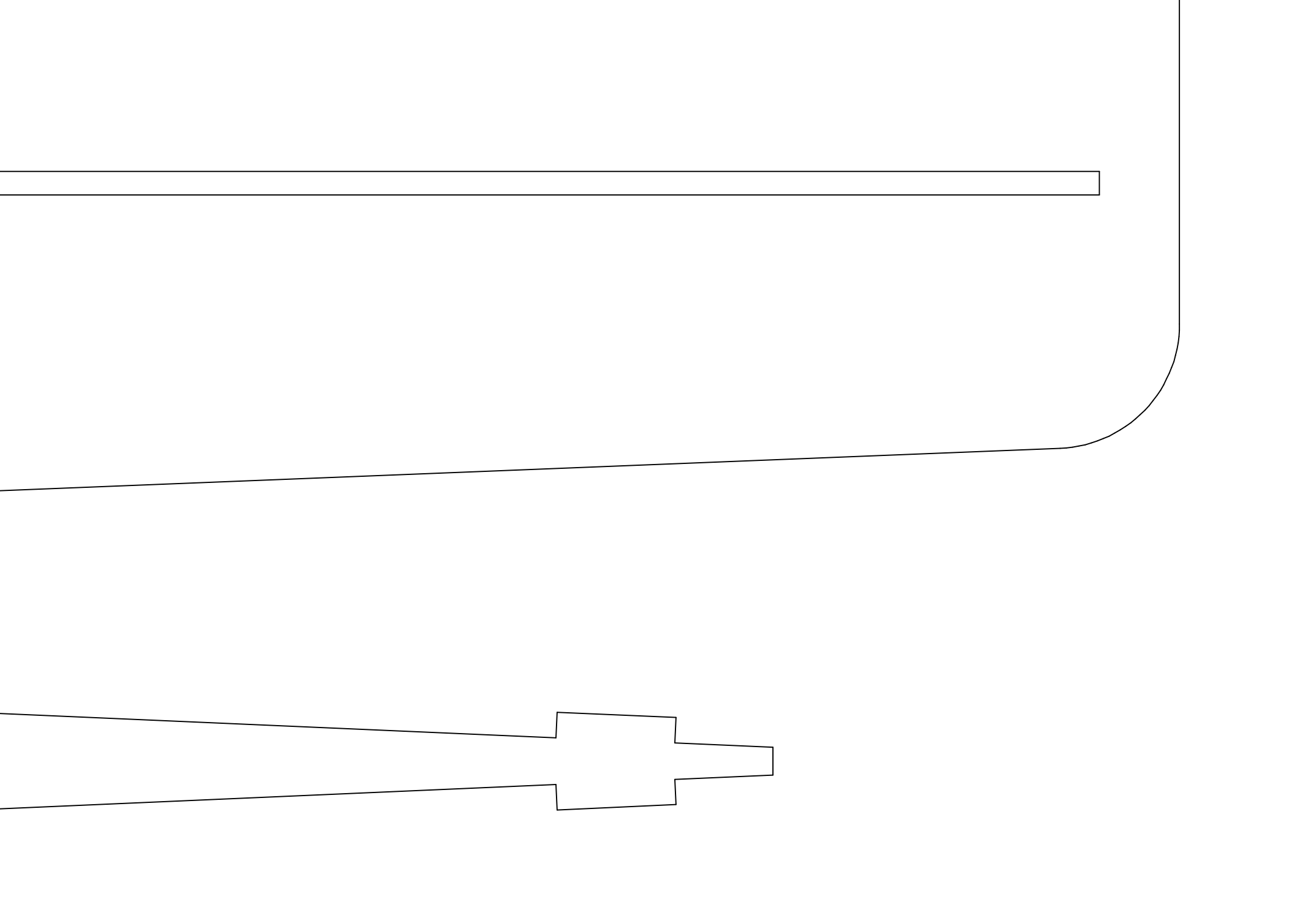

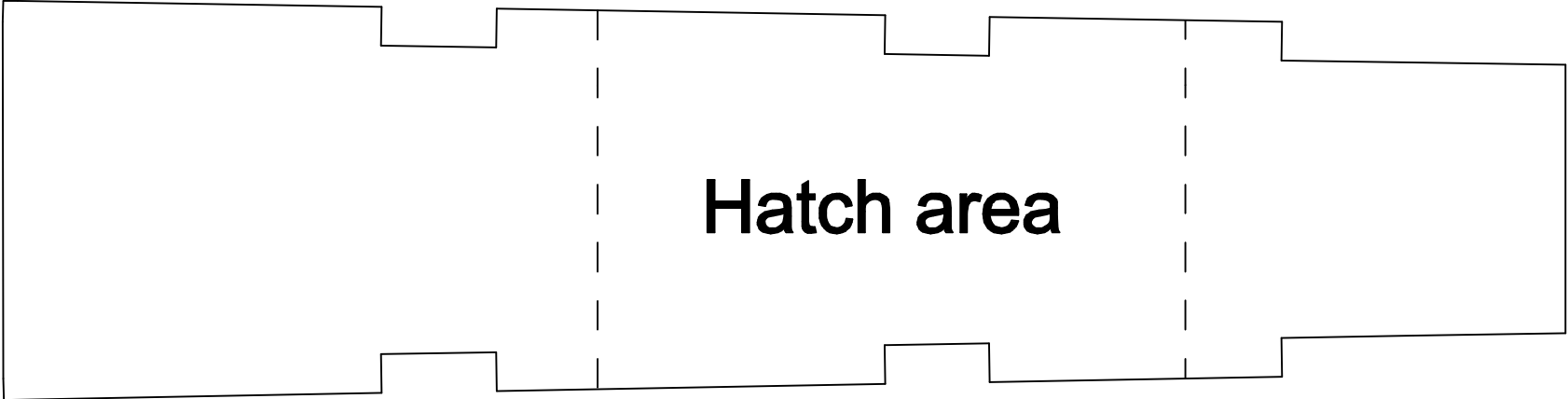

Hatch area

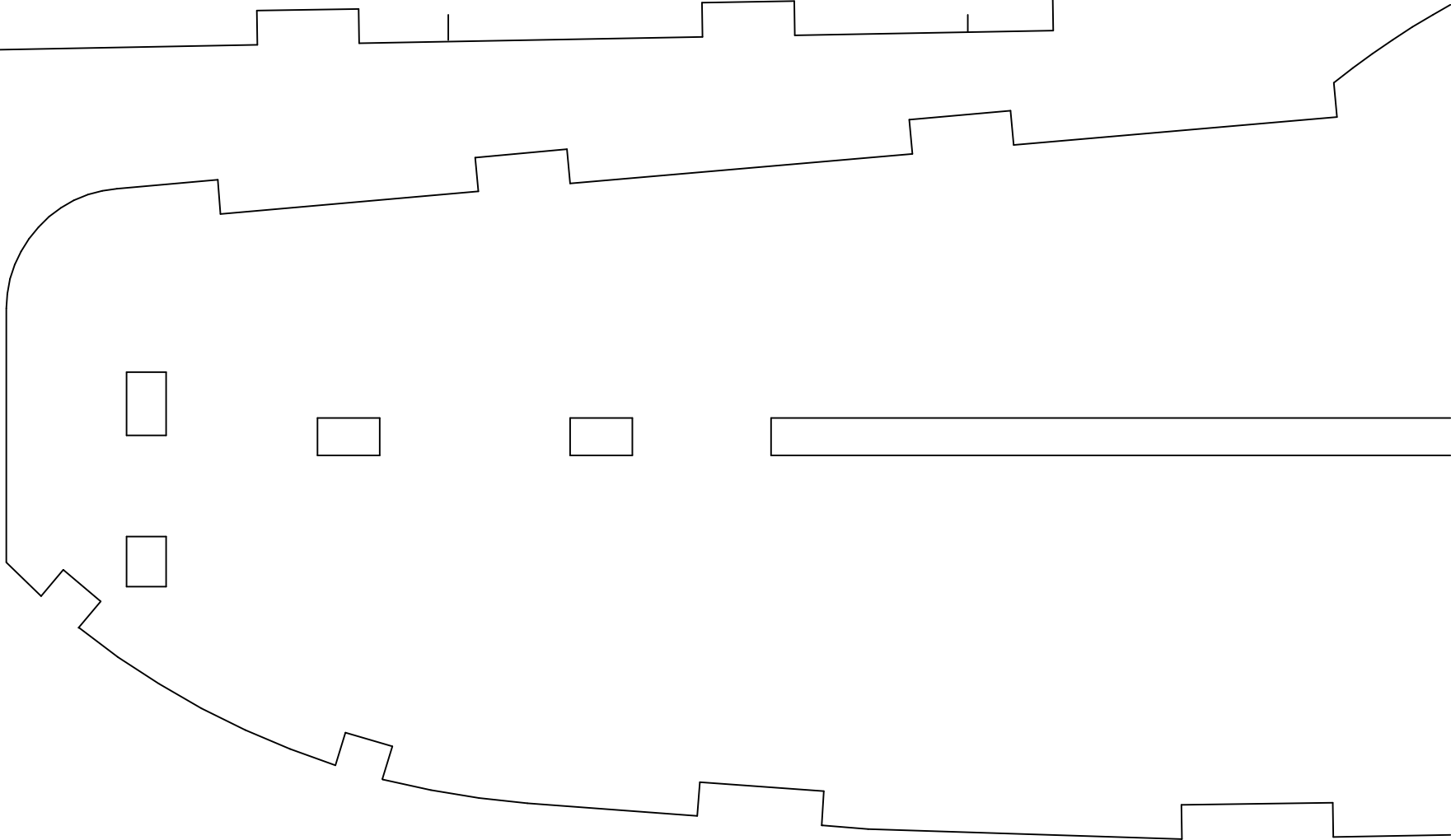

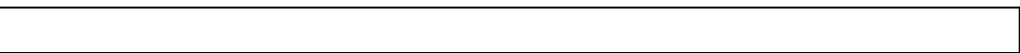
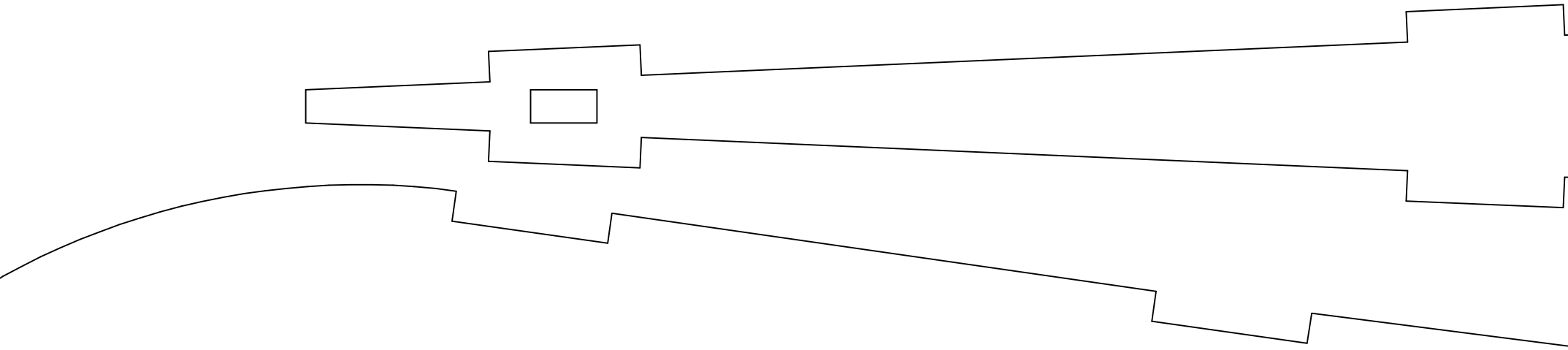

2 Sides needed

